



www.bfm-europe.com

Go direct to the Kinder website on your smart phone or tablet device, just scan in this QR code.



BFM Europe Limited, Trentham Lakes,
Stoke-on-Trent, Staffordshire ST4 4TJ

Tel: 01782 339000

www.bfm-europe.com

email: info@bfm-europe.com Fax: 01782 339009

Kinder

FIRES FOR LIFE

fires & surrounds 2012

With thanks to GB Mantels and Stanningley Firesides for supplying some of the fire surrounds used in this brochure.





Introduction & Our Guarantee

Kinder fires for life & Servicing and our guarantee 4

Before you begin 5



Kinder

FIRES FOR LIFE



high efficiency Inspired design. Advanced technology.

About Kinder high efficiency fires 6

Conventional flue

Hearth Mounted - Open Fronted

Nevada Plus 8

Kalahari Plus 10

Camber Plus 12

Oasis Plus 14

Hearth Mounted - Glass Fronted

Nevada HE 16

Kalahari HE 18

Camber HE 20

Oasis HE 22

Wall Mounted

Passion HE 24

Cameo HE 26

Proclaim HE 28

Atina HE 30

Eden HE 32

Suites

Avelli Suite 36

Balanced flue

Hearth Mounted

Dakota 42

Revolution 44

Wall Mounted

Cameo BF 26

Proclaim BF 28

Eden BF 32

Carmelo HE 34

Limours 46

Suites

Avelli BF Suite 36

Da Vinci Suite 38

Distinction Suite 40



At Kinder, we know how important it is to create a stylish and relaxing living environment.

That's why we've developed this collection of premium gas fires and surrounds to complement all tastes and lifestyles.



Hearth Mounted fires

Nevada 48

Kalahari 50

Camber 52

Black Magic 54

Oasis 56

Caesar 58



BFM Europe
BRITISH FIRE MANUFACTURERS

Today BFM Europe is the fastest growing domestic fire producer in the country with an unequalled reputation for quality and service. Every Kinder branded gas fire is developed and manufactured in Britain at our purpose built, state-of-the-art facility in Stoke-on-Trent.

Fascia options & technical info

Finishing touches 60

Kinder powerflue fires 62

Kinder fire surrounds 63

“ I believe our success stems from a combination of innovative design, investment in technology and the highest quality manufacturing standards. As a result all Kinder fires carry a 7 year guarantee to reflect my belief in their quality and durability, and our experienced Kinder retailers are hand-picked to give you the very best advice and service.

This brochure has been designed to make the purchase of your new Kinder fire as simple as possible. I hope you will find it both informative and inspiring. ”

Michael Dwan



There is nothing like the immediate warmth and comfort of a Kinder gas fire

Designed to suit your lifestyle with a combination of appealing looks, outstanding warmth and practical attention to detail - Kinder designs gas fires for all tastes, from traditional to contemporary, and including many models available as powerflue and balanced flue options.

All our fires feature a Flame Supervision Device (FSD) and all conventional flue models feature an Oxygen Depletion Sensor (ODS) for maximum safety. The ODS is a device which shuts off the gas supply to the main burner in the unlikely event of a fault. The FSD is a device which detects the presence of a flame, and in the absence of that flame, prevents uncontrolled release of gas to the burner.

Kinder products are stocked by leading independent fire specialists located throughout the UK. These retailers are fully trained to make the choice and subsequent installation of your Kinder fire as seamless as possible. By dialing 0800 040 7959 you will be connected directly to your nearest Kinder stockist. Alternatively you may prefer to visit our website at www.gas-fires.co.uk

Everything you need to know about gas fires, from alternative power supplies to flue types is on the following pages, so you can sit back and relax with Kinder from the start.



Kinder 7 year and lifetime guarantees

We understand that your gas fire is going to be the heart of your home. That's why we are passionate about ensuring our gas fires offer the ultimate in build quality and looks.



From the beginning, our Design Team sets the standard by creating new and innovative products, so you'll find exactly the fire you have in mind. Then there's our Development Team. They consistently deliver higher safety and efficiency ratings to give you total confidence.

Furthermore, before we commence manufacture, all models are assessed and approved by leading independent organisations and each fire rigorously checked by our Quality Control Department prior to leaving our state-of-the-art facility.

All in all, guaranteeing that when you settle down in front of a Kinder fire, you'll have the very best in gas fire technology behind it.

Every Kinder gas fire carries a 7 Year Comprehensive Guarantee providing you with reassurance and peace of mind. This means that your fire is guaranteed for seven years against manufacturing and material defects, including parts and labour.

There is also an Extended Lifetime Guarantee which covers all functional parts of the gas fire, excluding electronic components and labour costs. Both guarantees are subject to our 'Conditions of guarantee' including annual service and annual replacement of the oxy-pilot assembly.

We offer these guarantees, unlike other manufacturers, as a sign of our commitment to the highest standards of build quality, ensuring that life will revolve around your Kinder fire for many years to come. In-line with gas industry practice, we recommend that all gas appliances should be serviced annually by a Gas Safe Register engineer to ensure continued safe operation and optimum performance throughout the lifetime of the product. Gas Safe Register engineers are available directly through our Service Department.



Before you begin

There is a Kinder fire for all tastes, from traditional to contemporary chic. However, before you make your final selection, please take time to consider the following:

Radiant or Convector?

A **radiant fire** emanates heat from the combustion chamber only, which is why Kinder radiant fires incorporate a glowing back panel to maximise heat output. A **convector fire** has the added benefit of a heat exchanger attached to the back of the fire. This draws cool air in and sends it back out into the room as hot air, maximising heat output whilst keeping your fuel bills down.

Power

Your gas supply will either be Natural Gas or LPG, depending on the area in which you live.



Natural Gas - The most common gas supply.



LPG - Alternative for houses with no Natural Gas supply.

Chimney or Flue

Your choice of fire will be dictated by the type of chimney or flue you have. If you're not sure, then take a look at your roof and cross-reference it with the simple guide on the right. It is also worth noting that a slimline fire will fit virtually any chimney or flue, whereas a full-depth often requires a traditional chimney or rebate on the fire surround.

Please confirm your flue type by consulting your Kinder Stockist before purchase.



Brick Chimney

A conventional brick chimney is recognisable by a chimney stack with a terracotta pot or gas terminal.

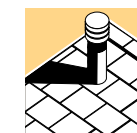

Pre-Fabricated Flue

This is an interlocking metal flue tube system identifiable by a metal flue and terminal on the roof and a metal flue box behind the fire.



Pre-Cast Flue

Built from concrete or clay blocks, pre-cast flues provide a rectangular section flue. They can be identified by a ridge vent or metal flue tube and terminal on the roof. All fires featuring this icon are suitable for pre-cast flues conforming to BS EN 1858.

No Chimney or Flue

Some properties have no chimney or flue, in which case a balanced flue or powerflue is required.



Powerflue fires expel the flue gases directly outside the building through the use of an electronically driven fan unit mounted on the external wall. A sophisticated microprocessor monitors performance and automatically shuts off the fire in the unlikely event of operation failure.

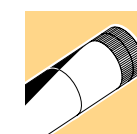

Balanced Flue fires vent directly outside through a horizontal co-axial pipe (one pipe within a larger pipe). The outer pipe draws air in from the outside and the inner pipe expels combustion gases. An electricity supply is not required for these products.

Controls

Gas is wonderfully controllable, but which type of control suits you best? The discretion of manual ignition, concealed behind the removable ash pan... the convenience of slide control...or the luxury and style of remote control?



Manual Control

Simple and discreet. The control system is located behind the fire's fret or trim. Once the fire is lit rotate the control knob to adjust the flame height and heat output.

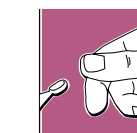

Slide Control

A convenient control system which is located on the top right-hand side of the fire. Push and hold the lever down to ignite and move it up and down to adjust the flame height and heat output.



Semi Remote Control

Light the fire using the manual control system located behind the fire's trim or fret then use the remote control handset to adjust the flame height and heat output.



Fully Automatic Easy Flame Control

Discreet, easy access buttons are used to ignite the fire and adjust heat and flame height



Fully Remote with Thermostat

The remote control handset can be used to light the fire as well as to adjust the flame height and heat output. In addition, the handset contains the extra benefit of a thermostatic control to regulate room temperature and a programmable timer that can be pre-programmed to ensure your room will be warm whenever you wish.



Fully Remote Control

The remote control handset is used to light the fire as well as to adjust the flame height and heat output.



Touchlight

Control via two switches, On/Off & High/Low.

Fire Back Panel

Kinder offers a range of fire back panels chosen to compliment each individual fire. In some cases you may be offered a choice of back panel – look out for the symbols on the right.



Plain Back

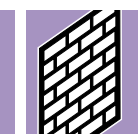

Stone Brick Back

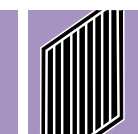

Black Ribbed Back

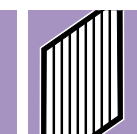

Cream Ribbed Back



Get up to 94% net efficiency from your Kinder High Efficiency gas fire

Kinder has always had a reputation as a manufacturer of some of the most efficient fires on the market. Now we are setting new industry standards with the Kinder HE high efficiency range: exceptional heat output combined with lower running costs compared to standard gas fires.

Kinder's R&D team has invested in developing the technology to meet the key objective of producing gas fires that save energy and as a result, help to keep costs down.



Inspired design Advanced technology

Glass fronted HE fires

Hearth Mounted Glass Fronted



Camber HE Page 20

Hole in the Wall Glass Fronted



Proclaim HE Page 28

This type of high efficiency fire has a glass panel across the front of the fire which radiates the heat generated from the fuel bed directly into the room. The glass panel concentrates the radiant heat so that more heat is forced into the room and less is lost through the chimney. Combined with convected heat which is produced by cool air drawn into the base of the fire through the heat exchanger and then emitted as warm air through the gap above the canopy, this makes glass fronted HE's the most efficient conventional flue fires available.

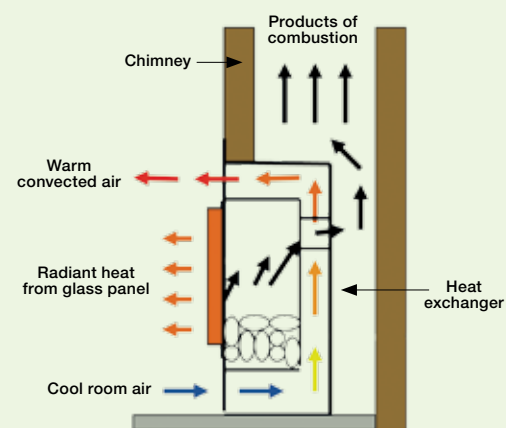

- Nevada HE Page 16
- Oasis HE Page 22
- Kalahari HE Page 18
- Avelli Suite Page 36

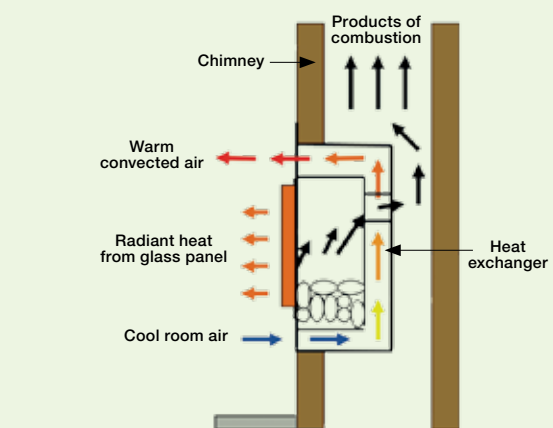

- Passion HE Page 24
- Atina HE Page 30
- Cameo HE Page 26
- Eden HE Page 32

Open fronted HE fires



Oasis Plus Page 14

Open fronted HE fires provide the look and feel of a real open fire with net efficiencies of up to 74%. This type of fire provides both radiant and convected heat. Radiant heat is emitted from the coal effect fuel bed and the convected heat is generated by cool air drawn into the base of the fire which passes through a heat exchanger and is then emitted as warm air through the gap above the canopy.

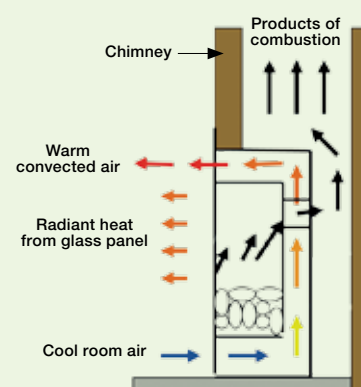

- Nevada Plus Page 8
- Camber Plus Page 12
- Kalahari Plus Page 10

Balanced Flue HE fires



Revolution Page 44

Designed for those who want all the benefits of a gas fire but don't have a built in chimney or flue in their home. A balanced flue fire comes with its own flue terminal which is vented directly through an outside wall. They are glass fronted, completely room sealed appliances and work by drawing and venting external air via a pair of co-axial tubes into the fire for combustion purposes. The radiant heat generated from the fuel-bed combines with convected heat, which is produced by cool air drawn into the base of the fire through the heat exchanger and then emitted as warm air through the gap above the canopy, making balanced flues one of the most efficient types of gas fires available.

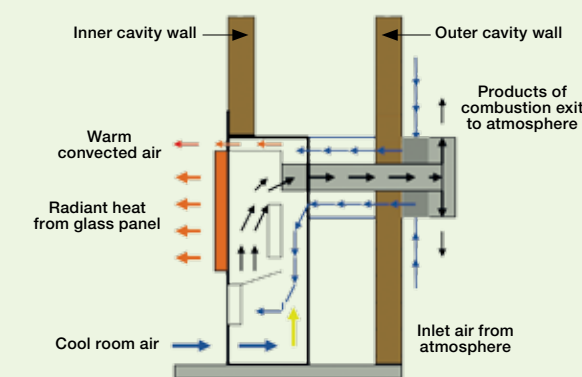

- Cameo BF Page 26
- Da Vinci BF Suite Page 38
- Proclaim BF Page 28
- Distinction BF Suite Page 40
- Eden BF Page 32
- Dakota Page 42
- Carmelo BF Page 34
- Limours Page 46
- Avelli BF Suite Page 36



The Nevada Plus is one of the most efficient open-fronted slimline gas fires available today and with a heat output of up to 4.1kW it is also one of the warmest products suitable for a pre-cast flue.

70% net efficiency

The Nevada Plus is available in a choice of manual, remote or our easy access Easy Flame control systems. This extremely versatile fire can be styled with a wide range of Kinder trims, frets or fascias and with an optional pebble fuel bed it is easy to create a look to suit your existing décor. See pages 60 to 61 for more information about Kinder accessories.

Specifications

Safety	FSD & ODS
Type of heat	Radiant & Convected
Heat Input - HIGH	6.5kW
Heat Input - LOW	2.2kW
Heat Output - HIGH	4.1kW
Heat Output - LOW	1.4kW
Air vent required	Not normally

N.B. Heat output and efficiency may differ slightly depending on type fuel effect.

Options

Fuel



Natural Gas

Chimney or Flue



Brick Chimney Pre-Fabricated Pre-Cast

Control



Manual Fully Automatic Easy Flame Control Fully Remote

Back design



Plain

Dimensions

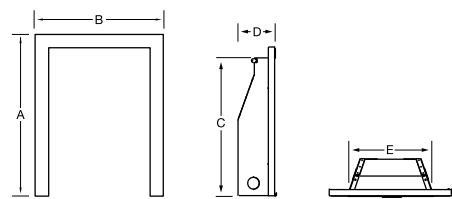

A 600mm
B 498mm
C 548mm
D 120mm
E 324mm

Dimensions A & B refer to standard trims only.



Nevada Plus with Profiled trim in silver and Bauhaus fret in polished silver with pebble fuel effect.



Nevada Plus with Profiled trim in brass and Dallas fret in brass with coal fuel effect



The Kalahari Plus high efficiency gas fire boasts an impressive 70% net efficiency and can be installed in to almost any chimney or flue, including Pre-cast when fitted with a 3" rebated fire surround.

70% net efficiency

This open-fronted gas fire features a highly realistic coal fuel effect and is available as a manual, slide, easy flame or remote controlled fire. Comes with coal fuel effect as standard. A pebble fuel bed pack is available as an optional extra..

The Kinder Kalahari can be styled with most trims, frets and fascias in our wide range of gas fire accessories on pages 60-61.

Specifications

Safety	FSD & ODS
Type of heat	Radiant & Convected
Heat Input - HIGH	6.9kW
Heat Input - LOW	4.2kW
Heat Output - HIGH	4.4kW
Heat Output - LOW	2.2kW
Air vent required	Not normally



Options

Fuel







Natural Gas

Chimney or Flue

Brick Chimney Pre-Fabricated Pre-Cast

Control

Manual Slide Fully Automatic Easy Flame Control Fully Remote Control

Back design



Plain

Dimensions

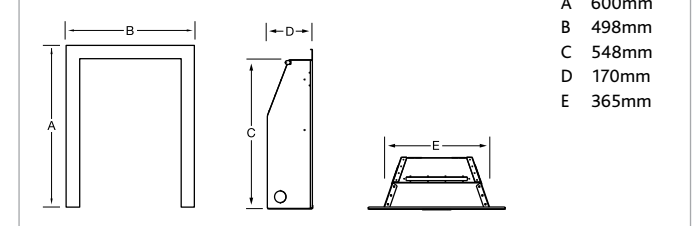

- A 600mm
- B 498mm
- C 548mm
- D 170mm
- E 365mm

Dimensions A & B refer to standard trims only.



Kalahari Plus with pebble fuel effect, Designer trim in silver & black and Vegas fret in polished silver.



Kalahari Plus with coal fuel effect, Designer trim in silver & black and Vegas fret in polished silver



The Camber Plus is certainly a contemporary classic with a wonderfully sleek design that will never go out of fashion.

This open-fronted gas fire provides an incredible 4.4kW heat output with a net efficiency of 70%. The Camber Plus is available in both manual and remote control versions and a coal fuel bed pack can be purchased as an optional extra.

70% net efficiency

Specifications

Safety	FSD & ODS
Type of heat	Radiant & Convected
Heat Input - HIGH	6.9kW
Heat Input - LOW	4.2kW
Heat Output - HIGH	4.4kW
Heat Output - LOW	2.2kW
Air vent required	Not normally

Options

Fuel



Natural Gas

Chimney or Flue



Brick Chimney



Pre-Fabricated



Pre-Cast

Control



Manual



Fully Remote

Back design



Plain

Dimensions

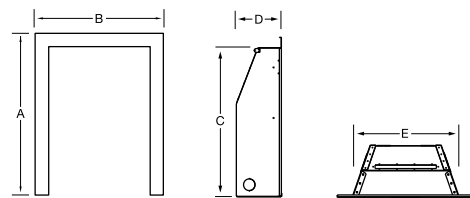

- A 610mm
- B 520mm
- C 548mm
- D 170mm
- E 365mm

Dimensions A & B refer to standard trims only.



Camber Plus with coal fuel effect.



Camber Plus with pebble fuel effect 13



The Oasis Plus is the first full depth open-fronted high efficiency gas fire from Kinder. You can now achieve the look of a real open coal fire, combined with the convenience of gas fuel, at an incredible 74% net efficiency.

74%
net efficiency









This stunning fire features an extra wide coal fuel effect bed, a beautiful flame picture and offers an incredible 4.6kW heat output.

Suitable for installation into standard brick chimneys and pre-fabricated flues, the Oasis Plus comes in a choice of manual, slide, easy flame or remote control and can be styled to suit your home with our wide range of trims and frets (see pages 58-60 for further details).

Specifications

Safety	FSD & ODS
Type of heat	Radiant & Convected
Heat Input - HIGH	6.9kW
Heat Input - LOW	4.2kW
Heat Output - HIGH	4.6kW
Heat Output - LOW	2.3kW
Air vent required	Not normally

Options

<p>Fuel</p>  <p>Natural Gas</p>	<p>Chimney or Flue</p>   <p>Brick Chimney Pre-Fabricated</p>
<p>Control</p>     <p>Manual Slide Fully Automatic Easy Flame Control Fully Remote Control</p>	<p>Back design</p>  <p>Plain</p>

Dimensions

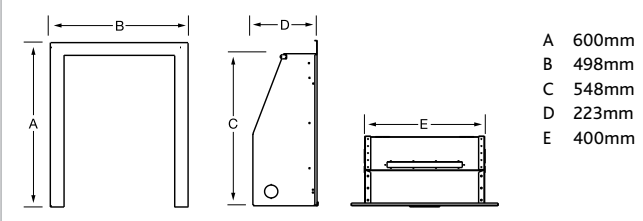

Dimensions A & B refer to standard trims only.





This slimline high efficiency fire boasts a net efficiency of up to 89% and will fit almost any chimney or flue including Pre-Cast (BS EN 1858).







With a choice of coal or pebble fuel bed the Nevada HE also features a large viewing window and an incredible 3.2kW heat output. Create your own style with a choice of trim or fret combination from the extensive range on pages 60-61.

70%
net efficiency

Specifications

Safety	FSD & ODS
Type of heat	Radiant & Convected
Heat Input - HIGH	4.0kW
Heat Input - LOW	2.0kW
Heat Output - HIGH	3.2kW
Heat Output - LOW	1.4kW
Air vent required	Not normally

Options

<p>Fuel</p>  <p>Natural Gas</p>	<p>Chimney or Flue</p>    <p>Brick Chimney Pre-Fabricated Pre-Cast</p>
<p>Control</p>   <p>Manual Slide</p>	<p>Back design</p>  <p>Plain</p>

Dimensions

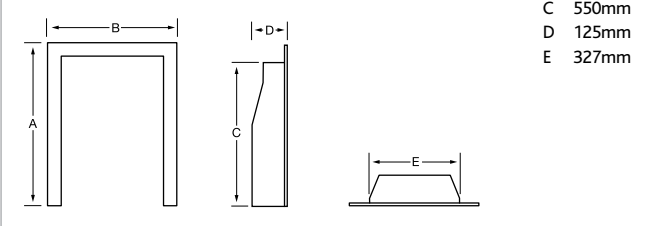

Dimensions A & B refer to standard trims only.



Nevada HE with pebble fuel effect, Standard trim and Athena fret in a polished silver finish.



Nevada HE with coal fuel effect, Standard trim and Athena fret in a brass finish



With a net efficiency of 78%, the Kalahari HE has been designed to fit most flue types including Pre-Cast flues when installed with a 3" rebated fire surround.

As well as manual or slide control options you can also enjoy the luxury of a fully remote control system on the Kalahari HE. Comes with coal fuel effect as standard. A pebble fuel bed pack is available as an optional extra. Choose any trim and fret combination from the Kinder fascia range on pages 60-61 to complement your living area.

78%
net efficiency

Specifications

Safety	FSD
Type of heat	Radiant & Convected
Heat Input - HIGH	4.5kW
Heat Input - LOW	3.5kW
Heat Output - HIGH	3.2kW
Heat Output - LOW	2.4kW
Air vent required	Not normally

Options

Fuel

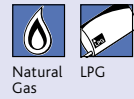

Natural Gas
LPG

Chimney or Flue

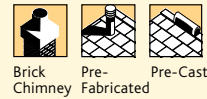

Brick Chimney
Pre-Fabricated
Pre-Cast

Control



Manual
Slide
Fully Remote

Back design



Plain

Dimensions

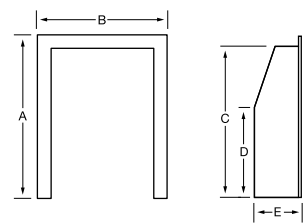

- A 598mm
- B 497mm
- C 550mm
- D 327mm
- E 180mm
- F 110mm
- G 365mm

Dimensions A & B refer to standard trims only.



Kalahari HE with pebble fuel effect, Chamfered trim and Athena fret in a polished silver finish.

Kalahari HE



high efficiency



Kalahari HE with coal fuel effect, Chamfered trim and Athena fret in a polished silver finish



The stylish silver fascia combined with a black ribbed interior and cool beach pebbles make the Camber HE a welcome centre-piece in any modern living room.

78% net efficiency

Boasting a net efficiency of 78% the Camber HE is economical as well as eye-catching. It is also suitable for most conventional flue chimneys including pre-cast when installed with a 3" rebated fire surround. Manual and remote controlled models are available.

Specifications

Safety	FSD
Type of heat	Radiant & Convected
Heat Input - HIGH	4.5kW
Heat Input - LOW	3.5kW
Heat Output - HIGH	3.2kW
Heat Output - LOW	2.4kW
Air vent required	Not normally

Options

Fuel



Natural Gas

Chimney or Flue



Brick Chimney



Pre-Fabricated



Pre-Cast

Control



Manual



Fully Remote

Back design



Ribbed

Dimensions

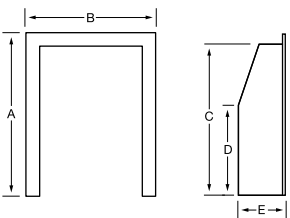

- A 610mm
- B 520mm
- C 550mm
- D 327mm
- E 180mm
- F 110mm
- G 365mm

Dimensions A & B refer to standard trims only.





Based on our most popular hearth mounted fire, the Oasis HE is the first model in the Kinder 'high efficiency' range.

The Oasis HE has an incredible 89% net efficiency and 4kW heat output, ensuring that this fire gives optimum heat combined with cost efficiency. This glass fronted product is available with all Kinder trim and fret combinations allowing you to personalise the look and style of your fire – see pages 60-61 for options.

89%
net efficiency

Specifications

Safety	FSD & ODS
Type of heat	Radiant & Convected
Heat Input - HIGH	5.0kW
Heat Input - LOW	3.5kW
Heat Output - HIGH	4.0kW
Heat Output - LOW	2.3kW
Air vent required	Not normally

Options

Fuel

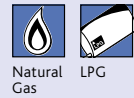

Natural Gas
LPG

Chimney or Flue



Brick Chimney
Pre-Fabricated

Control



Manual
Slide
Fully Remote

Back design



Plain

Dimensions

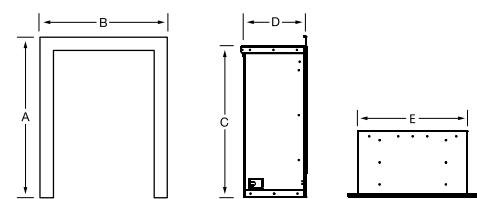

- A 598mm
- B 497mm
- C 550mm
- D 230mm
- E 400mm

Dimensions A & B refer to standard trims only.





The Passion is a highly stylish glass fronted hole-in-the-wall fire and boasts a 78% net efficiency.

Its compact, portrait dimensions and clean lines make it ideal for modern day living, and it perfectly complements a contemporary, minimalist setting. The Passion HE features a black ribbed back with either a coal or pebble fuel bed and a choice of two trim colours: champagne or polished silver.

78%
net efficiency

Specifications

Safety	FSD
Type of heat	Radiant & Convected
Heat Input - HIGH	4.5kW
Heat Input - LOW	3.5kW
Heat Output - HIGH	3.2kW
Heat Output - LOW	2.4kW
Air vent required	Not normally

Options

Fuel



Natural Gas

Chimney or Flue

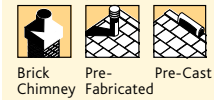

Brick Chimney, Pre-Fabricated, Pre-Cast

Control

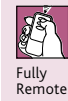

Fully Remote

Back design



Ribbed

Dimensions

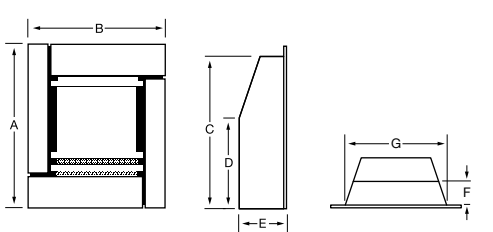

- A 715mm
- B 600mm
- C 550mm
- D 327mm
- E 180mm
- F 110mm
- G 365mm



Passion HE with pebble fuel effect and champagne trim.





The petite dimensions of the Cameo HE make it perfect for modern living areas where space can be at a premium.

This stunning high efficiency hole-in-the-wall fire comes with a highly realistic log fuel bed and is available in a choice of black or cream ribbed back panels and a variety of stylish, dual colour designer fascias in bronze and champagne, black and silver or black and black.

87%*

net efficiency

*on conventional flue

Specifications

	Balanced Flue (BF)	Conventional Flue (CF)
Safety	FSD	FSD & ODS
Type of heat	Radiant & Convected	Radiant & Convected
Heat Input - HIGH	5.5kW	4.4kW
Heat Input - LOW	3.0kW	3.1kW
Heat Output - HIGH	4.2kW	3.5kW
Heat Output - LOW	2.3kW	2.5kW
Air vent required	Not normally	Not normally

Options

Fuel



Natural Gas

Chimney or Flue



Brick Chimney Pre-Fabricated Balanced

Control



Semi Remote*



Fully Remote with Thermostat**

Back design



Black Ribbed



Cream Ribbed

*Balanced flue only **Conventional flue only.

Dimensions

Conventional Flue

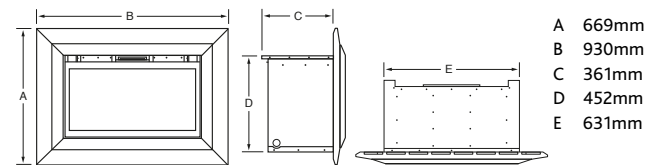

Balanced Flue

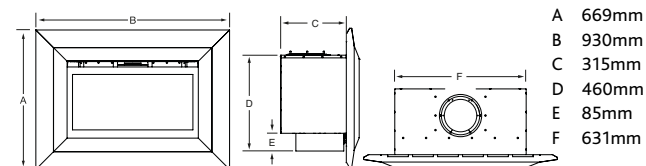

An optional 25mm or 50mm spacer is available if required.



Cameo HE with black ribbed back and black & silver trim.



Cameo HE with black ribbed back and black trim.



Cameo HE with cream ribbed back and bronze & champagne trim



With a heat output of 4.3kW and net efficiency of up to 87% the Proclaim HE is one of the most economical hole-in-the-wall fires available for standard brick chimney installation.

87%

net efficiency

The Proclaim HE features a beautifully realistic log fuel bed and a choice of two models; a stylish black and polished silver fascia with black back panels and bronze and champagne fascia with cream back panels.

Specifications

	Balanced Flue (BF)	Conventional Flue (CF)
Safety	FSD	FSD & ODS
Type of heat	Radiant & Convected	Radiant
Heat Input - HIGH	7.5kW	5.4kW
Heat Input - LOW	3.5kW	3.0kW
Heat Output - HIGH	5.5kW	4.2kW
Heat Output - LOW	2.6kW	2.3kW
Air vent required	Not normally	Not normally

Options

Fuel



Natural Gas

Chimney or Flue



Brick Chimney Pre-Fabricated Balanced

Control



Semi Remote* Fully Remote with Thermostat**

Back design



Black Ribbed Cream Ribbed

*Balanced flue only **Conventional flue only.

Dimensions

Conventional Flue

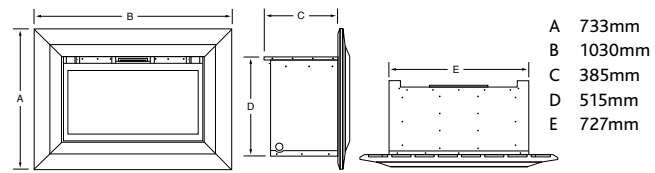

Balanced Flue

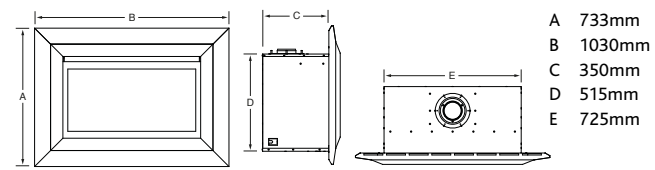

An optional 25mm or 50mm spacer is available if required.



Proclaim HE with cream ribbed back and bronze & champagne trim.



Proclaim HE with black ribbed back and black trim.





Atina HE



high efficiency

The Atina HE's perfect petite proportions and fabulous black reflective interior combined with a spellbinding flame makes this little hole-in-the-wall gas fire a magnificent centre-piece for smaller modern living areas.

77% net efficiency

The Atina HE features a maximum heat output of 3.5kW and is controlled by a fully sequential remote control system* with thermostatic operation so you can always maintain a comfortable room temperature that suits you.

*A 240V 3amp mains electricity supply is required.
Please refer to installation manual for more information regarding installation requirements before you start the installation.

Specifications

Safety	FSD & ODS
Type of heat	Radiant & Convected
Heat Input - HIGH	5.0kW
Heat Input - LOW	3.0kW
Heat Output - HIGH	3.5kW
Heat Output - LOW	1.7kW
Air vent required	Not normally

All specifications shown relate to natural gas models only.

Options

Fuel

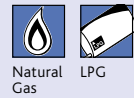

Natural Gas
LPG

Chimney or Flue



Brick Chimney
Pre-Fabricated

Control



Fully Remote with Thermostat

Back design



Plain

Dimensions

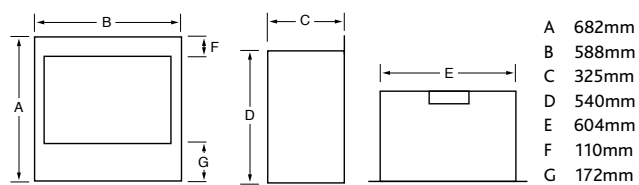

Wide fascia

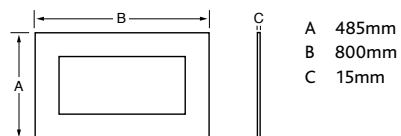

Glass fascia

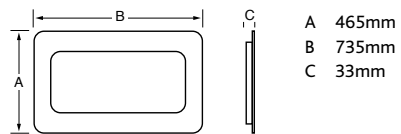

Atina HE with log fuel effect and Wide trim in antique brass.



Atina HE with white stones fuel effect.



Atina HE with log fuel effect and Glass trim in champagne.



Atina HE with white stones fuel effect and Glass trim in silver.



Atina HE with Glass trim in a rose finish.



Atina HE with white stones fuel effect and Wide trim in polished silver



This glass fronted landscape hole-in-the-wall fire has an incredible 83% net efficiency and up to 5.2kW heat output. It features an enchanting flame picture and comes with a choice of log or white stone fuel bed.

83%

net efficiency

The Eden HE has been designed as a trimless* fire for a very minimalist appearance, or team with an optional designer trim for a more prominent centrepiece.

*A 240V 3amp mains electricity supply is required to power the remote control system.

Please refer to installation manual for more information regarding installation requirements before you start the installation.

Specifications

	Balanced Flue (BF)	Conventional Flue (CF)
Safety	FSD	FSD & ODS
Type of heat	Radiant & Convected	Radiant & Convected
Heat Input - HIGH	6.3kW	6.9kW
Heat Input - LOW	2.0kW	3.5kW
Heat Output - HIGH	4.8kW	5.2kW
Heat Output - LOW	1.3kW	2.0kW
Air vent required	Not normally	Not normally

All specifications shown relate to natural gas models only.

Options

Fuel



Natural Gas LPG

Chimney or Flue



Brick Chimney Pre-Fabricated Balanced

Control



Fully Remote with Thermostat

Back design



Plain

Dimensions

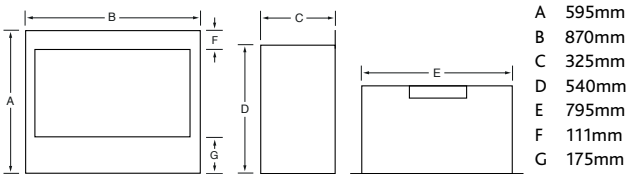

Dimensions for the Eden Balanced Flue model may vary please consult the installation manual for further details.

Slimline fascia

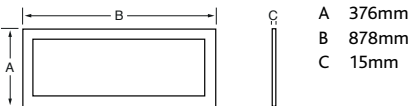

Deluxe fascia

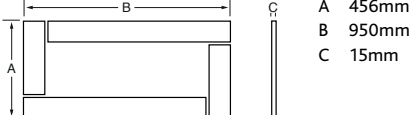

Eden HE with log fuel effect.



Eden HE with white stones fuel effect and Slimline trim in polished silver.



Eden HE with log fuel effect and Slimline trim in antique brass.



Eden HE with white stones fuel effect and Deluxe trim in satin silver.



Eden HE with log fuel effect and Deluxe trim in antique brass.





If you're looking for extravagance combined with exceptional heat output then the Carmelo HE is the ideal gas fire for you.

With a viewing area measuring 1145mm along with an enchanting flame picture this hole-in-the-wall fire is certainly a show-stopper, and with a heat output of 6.5kW and up to 75% net efficiency it provides exceptional performance too. What's more this fire can be installed almost anywhere in the home since it uses a balanced flue system with a choice of horizontal flue, vertical flue or chimney conversion flue kits available to choose from. Both log and white stone fuel beds are supplied with every fire.

*A 240V 3amp mains electricity supply is required to power the remote control system.







75% net efficiency

Specifications

Safety	FSD
Type of heat	Radiant & Convected
Heat Input - HIGH	9.5kW
Heat Input - LOW	5.5kW
Heat Output - HIGH	6.5kW
Heat Output - LOW	3.0kW
Air vent required	Not normally

Heat input and output figures refer to natural gas models and measured on 350mm horizontal flue duct in accordance with clause 7.11 of BS EN 613:2001.

Options

Fuel  Natural Gas  LPG	Chimney or Flue  Brick Chimney*  Balanced Chimney*
Control  Fully Remote with Thermostat	Back design  Plain

*When installed using a chimney conversion kit.

Dimensions

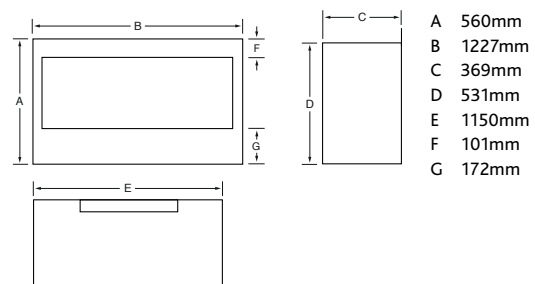

White stones fuel effect.





Avelli Suite



high efficiency

The Avelli gas fire suite is small in size but big in style. This beautiful fireplace comes in a choice of limestone or travertine surround and features a large, high efficiency gas fire with extremely realistic log effect fuel bed and a heat output of 4.2kW.

75%

net efficiency

The fire comes in a choice of black ribbed, cream ribbed or brick effect interior and is operated by a fully sequential remote control system.

This fire is suitable for installation in to a standard brick chimney or pre-fabricated flue. A balanced flue version is also available for homes without a standard chimney or flue system.

Specifications

	Balanced Flue (BF)	Conventional Flue (CF)
Safety	FSD	FSD & ODS
Type of heat	Radiant & Convected	Radiant & Convected
Heat Input - HIGH	5.7kW	6.2kW
Heat Input - LOW	4.4kW	4.8kW
Heat Output - HIGH	4.5kW	4.2kW
Air vent required	Not normally	Not normally

*Net efficiency refers to conventional flue models only. Balanced flue models have an 84% net efficiency.

Options

Fuel



Natural Gas

Chimney or Flue



Brick Chimney



Pre-Fabricated



Balanced

Control



Fully Remote with Thermostat

Back design



Stone Brick



Cream Ribbed



Black Ribbed

Dimensions

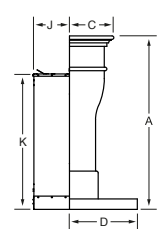
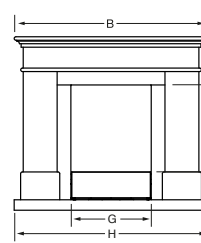

- A 997mm
- B 1114mm
- C 255mm
- D 380mm
- E 500mm
- F 220mm
- G 462mm
- H 1114mm
- I 528mm
- J 205mm
- K 779mm



Avelli Suite with cream ribbed back.



Avelli Suite with brick effect back.



Avelli Suite with brick effect back in travertine surround.



Avelli Suite with black ribbed back in limestone surround



This stunning fireplace is sure to be the centre of attention in any home. Its highly realistic log fuel bed is complemented by a beautiful and mesmerising lazy flame.

The classically designed surround will suit any decor and with a choice of brick effect or black ribbed back panels and Limestone or Travertine surround you can create either a traditional or contemporary look.

This balanced flue fire features thermostatic operation and an incredible 83% efficiency. A chimney conversion kit is available for installation into a standard brick chimney.







83%
net efficiency

Specifications

Safety	FSD
Type of heat	Radiant & Convected
Heat Input - HIGH	8.7kW
Heat Input - LOW	5.5kW
Heat Output - HIGH	6.5kW
Heat Output - LOW	3.5kW
Air vent required	Not normally

All figures measured on 350mm horizontal flue duct in accordance with clause 7.11 of BS EN 613 : 2001.

Options

Fuel  Natural Gas	Chimney or Flue   Brick Chimney Balanced
Control  Fully Remote with Thermostat	Back design   Stone Brick Ribbed

*When installed using a chimney conversion balanced flue kit.

Dimensions

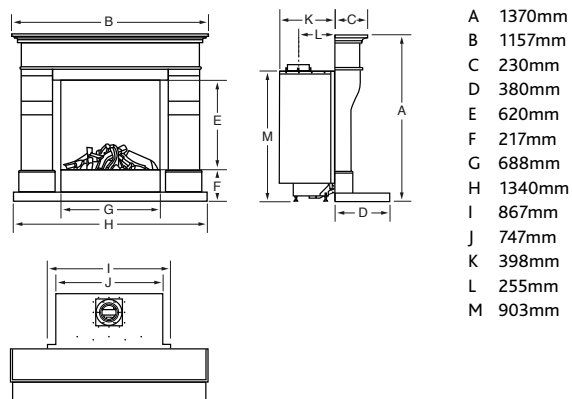

Da Vinci Suite with black back.



Da Vinci Suite with black back in a limestone surround.





Distinction Suite



high efficiency

The subtle chamfered edges of the Distinction combined with a realistic log fuel bed and beautiful mesmerizing flame create a luxurious and timeless quality.

83% net efficiency

A choice of brick effect or black ribbed back panels and Limestone or Travertine surround is available.

This balanced flue fire features thermostatic operation and an incredible 83% efficiency. A chimney conversion kit is available for installation into a standard brick chimney.

Specifications

Safety	FSD
Type of heat	Radiant & Convected
Heat Input - HIGH	8.7kW
Heat Input - LOW	5.5kW
Heat Output - HIGH	6.5kW
Heat Output - LOW	3.5kW
Air vent required	Not normally

All figures measured on 350mm horizontal flue duct in accordance with clause 7.11 of BS EN 613 : 2001.

Options

Fuel



Natural Gas

Chimney or Flue



Brick Chimney



Balanced Chimney

Control



Fully Remote with Thermostat

Back design



Stone Brick



Ribbed Brick

*When installed using a chimney conversion balanced flue kit.

Dimensions

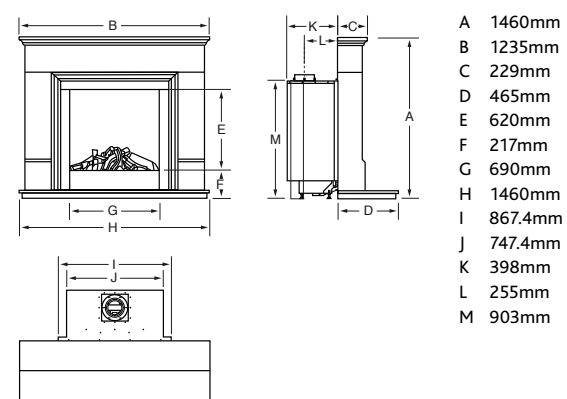

Distinction Suite with brick effect back.



Distinction Suite with brick effect back in a travertine surround.



Distinction Suite with black back in a limestone surround 41



Dakota Balanced Flue



high efficiency

The Dakota's stylish glass front is instantly eye-catching and helps ensure incredible efficiency.

As the Dakota is designed exclusively as a balanced flue model, home owners without a chimney can still enjoy the benefits of having a Kinder gas fire. Comes with the option of a brass, black or silver chamfered trim which can be teamed with any fret from our extensive range on page 61.

82%
net efficiency

Specifications

Safety	FSD
Type of heat	Radiant & Convected
Heat Input - HIGH	3.8kW
Heat Input - LOW	2.5kW
Heat Output - HIGH	2.8kW
Heat Output - LOW	1.7kW
Air vent required	Not normally

Options

Fuel



Natural Gas

Chimney or Flue



Balanced

Control



Manual

Back design



Black Brick

Dimensions

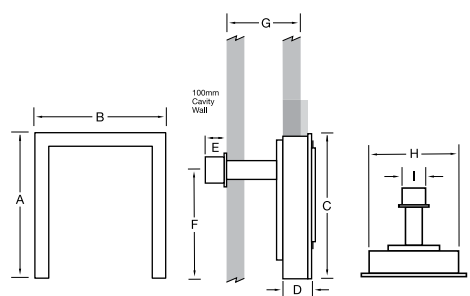

- A 620mm
- B 470mm
- C 580mm
- D 125mm
- E 95mm
- F 435mm
- G 675mm max - 130mm min
- H 400mm
- I 145mm



Dakota with Vegas fret in a black finish.



Dakota with Vegas fret in a polished silver finish.



Dakota with Vegas fret in a brass finish



Designed to fit into a standard cavity wall with a 3" rebated surround the Revolution Balanced Flue gas fire boasts net efficiency of up to 94% and features a full depth coal fuel effect.

94%
net efficiency

The Revolutions is available in manual, remote or with a fully automatic Easy Flame control option with discreet, easy access buttons which ignites the fire and allows you to adjust the heat and flame height to suit your needs.

This glass fronted fire has an exceptionally large viewing area and can be styled with a variety of trims and frets available from the Kinder accessories range on pages 60-61.

Specifications

Safety	FSD
Type of heat	Radiant & Convected
Heat Input - HIGH	4.6kW
Heat Input - LOW	3.0kW
Heat Output - HIGH	4.3kW
Air vent required	Not normally

Options

Fuel

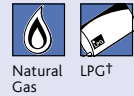

Natural Gas
LPG†

Flue



Balanced

Control



Manual



Fully Remote



Fully Automatic Easy Flame Control

Back design



Plain

†Only available with Manual Control.

Dimensions

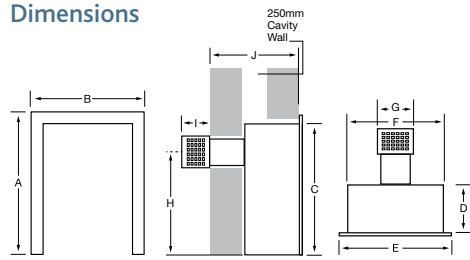

- A 598mm
- B 497mm
- C 551mm
- D 185mm
- E 486mm
- F 406mm
- G 150mm
- H 423mm min
- I 200mm min
- J 285mm min - 615mm max*

*Optional flue duct extension available to increase maximum length to 985mm.



Revolution with Camber fascia in silver.

Revolution Balanced Flue



high efficiency



Revolution with Standard trim and Aegis fret in a polished silver finish



Limours Balanced Flue



high efficiency

The Limours is Kinder's first dedicated wall mounted balanced flue fire. No chimney is required as this fire is flued directly through an outside wall. It can be simply hung on the wall with no need for any extensive building work or recessed when fitted with an additional wall plate.





87% net efficiency

The Limours is operated via a thermostatic remote control and features a contemporary graphite fascia with stainless steel detail and an aggregate stone effect fuel bed.

Specifications

Safety	FSD
Type of heat	Radiant & Convected
Heat Input - HIGH	4.8kW
Heat Input - LOW	2.2kW
Heat Output - HIGH	4.2kW
Air vent required	Not normally

Options

Fuel   Natural Gas LPG	Flue  Balanced
Control  Fully Remote with Thermostat	Back design  Ribbed

Dimensions

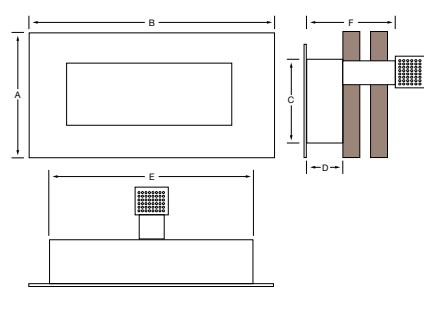

Hang on Wall Installation

- A 685mm
- B 1110mm
- C 612mm
- D 145mm
- E 747mm
- F 245mm min - 545mm max*

*Optional flue duct extension available to increase maximum length to 985mm.

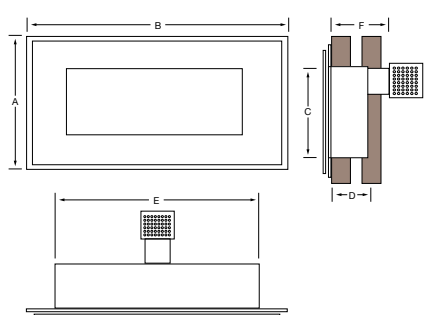

Inset Installation

- A 739mm
- B 1164mm
- C 612mm
- D 100mm
- E 747mm
- F 200mm min - 500mm max*

*Optional flue duct extension available to increase maximum length to 900mm.



Limours in a wall inset installation using optional wall plate.



Limours with optional brushed steel trim 47



With its ultra slim design, the Nevada will fit beautifully into almost any fireplace and is also available in a powerflue version for homes without a chimney or flue.

With the natural ambient glow of real-effect coals and flames, it will suit your lifestyle and your home perfectly. A pebble fuel bed pack is available as an optional extra and you can create your own look by choosing a trim and fret combination from our extensive range on pages 60-61.

Specifications

	Conventional Flue (CF)	Powerflue (PF)
Safety	FSD & ODS	FSD & ODS
Type of heat	Radiant	Radiant
Heat Input - HIGH	6.5kW	6.5kW
Heat Input - LOW	4.2kW	4.2kW
Heat Output - HIGH	3.3kW	3.2kW
Heat Output - LOW	1.5kW	1.9kW
Air vent required	Not normally	Not normally

Options

Fuel



Natural Gas

Flue



Brick Chimney



Pre-Fabricated



Pre-Cast



Powerflue†

Control



Manual



Slide

Back design



Plain

†Available in Manual Control only.

Dimensions

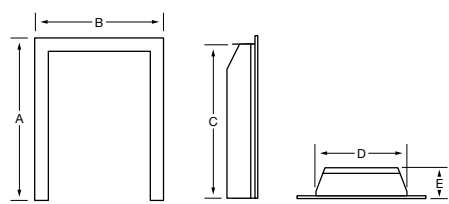

- A 598mm
- B 497mm
- C 550mm
- D 325mm
- E 100mm

For Powerflue dimensions please see page 62.
Dimensions A & B refer to Standard trims only.

Nevada



Nevada with coal fuel effect, Designer trim in black & brass and Dallas fret in antique brass finish. 49



Kalahari

The Kalahari instantly brings a room to life. This market leading radiant offers the appearance of a real open fire and incorporates a full-depth ceramic coal fuel effect for beautifully realistic flames and an inviting charm.

Designed to fit snugly into a pre-cast flue with a 3" rebated fire surround, this fire exudes a welcoming heat output of up to 3.3kW. The Kalahari is available in a choice of manual, slide or fully automatic remote control. The Kalahari Powerflue features an electronic Touchlite control – see page 5 for details. A pebble fuel bed pack is available as an optional extra.

Specifications

	Conventional Flue (CF)	Powerflue (PF)
Safety	FSD & ODS	FSD & ODS
Type of heat	Radiant	Radiant
Heat Input - HIGH	6.9kW	6.9kW
Heat Input - LOW	4.2kW	4.2kW
Heat Output - HIGH	3.3kW	3.2kW
Heat Output - LOW	1.5kW	2.0kW
Air vent required	Not normally	Not normally

Options

Fuel

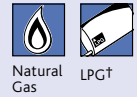

Natural Gas
LPG†

Flue

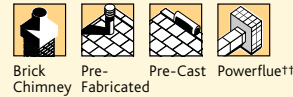

Brick Chimney
Pre-Fabricated
Pre-Cast
Powerflue††

Control

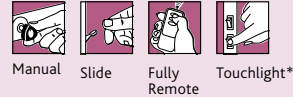

Manual
Slide
Fully Remote
Touchlight*

Back design



Plain

†Only available on Manual or Slide Control ††Only available with Manual or Touchlight Control
*Only available on Powerflue models.

Dimensions

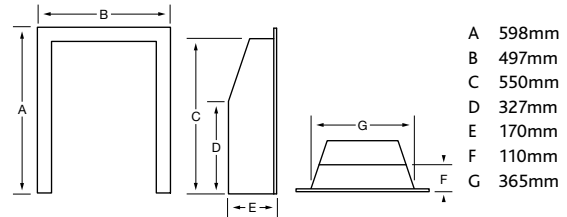

- A 598mm
- B 497mm
- C 550mm
- D 327mm
- E 170mm
- F 110mm
- G 365mm

For Powerflue dimensions please see page 62.
Dimensions A & B refer to Standard trims only.



Kalahari with pebble fuel effect, Designer trim and Bauhaus fret in a silver finish.



Kalahari with coal fuel effect, Designer trim and Bauhaus fret in a silver finish



Camber

The Camber's contradictory balance of cool beach pebbles and blazing dancing flames captivate you on entering the room. Precision manufacturing and the unique pebble design provide an individual combination of aesthetic beauty with high quality performance.

Camber Black features black ribbed back panels, cool grey pebbles and a silver fascia. Camber Cream features a champagne fascia, cream ribbed back panels and a warm beige pebble fuel bed.

A coal fuel effect is available as an optional extra.

Don't have a chimney? Don't worry. This breathtaking fire is also available as a Powerflue model.

Specifications

Model Performance	Conventional Flue (CF)	Powerflue (PF)
Safety	FSD & ODS	FSD & ODS
Type of heat	Radiant	Radiant
Heat Input - HIGH	6.9kW	6.9kW
Heat Input - LOW	4.2kW	4.2kW
Heat Output - HIGH	3.3kW	3.6kW
Heat Output - LOW	1.5kW	2.0kW
Air vent required	Not normally	Not normally

Options

Fuel



Natural Gas

Chimney or Flue



Brick Chimney Pre-Fabricated Pre-Cast Powerflue†

Control



Manual Fully Remote

Back design



Ribbed

†Only available with Manual Control.

Dimensions

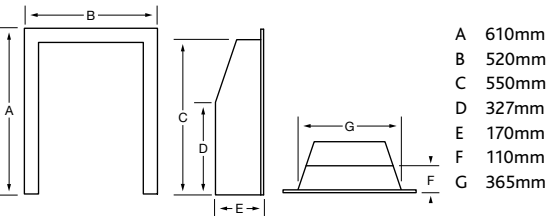

For Powerflue dimensions please see page 62.



Camber Black with coal fuel effect.



Camber Cream.



Camber Black with pebble fuel effect 53



The Black Magic is a contemporary coal effect gas fire that fits in to almost all flue types including pre-cast with a 3" rebated fire surround.

Providing the finishing touch to this stunning design is the contemporary fascia which is made from high quality extruded aluminium and comes in a beautiful black textured paint finish. The Black Magic is also available in a powerflue model.

Specifications

	Conventional Flue (CF)	Powerflue (PF)
Safety	FSD & ODS	FSD & ODS
Type of heat	Radiant	Radiant
Heat Input - HIGH	6.9kW	6.9kW
Heat Input - LOW	4.2kW	4.2kW
Heat Output - HIGH	3.3kW	3.6kW
Heat Output - LOW	1.5kW	2.0kW
Air vent required	Not normally	Not normally

Options

Fuel

Natural Gas LPG+

Chimney or Flue

Brick Chimney Pre-Fabricated Pre-Cast Powerflue+

Control

Manual Fully Remote

Back design

Plain

†Only available with Manual Control

Dimensions

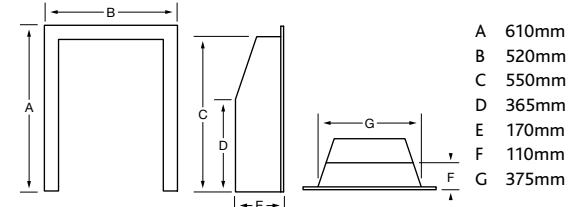

For Powerflue dimensions please see page 62.

Black Magic





The Oasis successfully marries classic looks with state-of-the-art performance and is currently one of the warmest open-fronted convector fires with a heat output of up to 4.0kW.

The full depth fuel, highly realistic fuel effect provides a mesmerising flame picture with a cosy glow ensuring an attractive centrepiece in any room. There is also a low lintel option available, along with a wide choice of trim and fret combinations in contemporary or traditional styles. See pages 60-61 for details.

Specifications

	Oasis & Oasis Low Lintel
Safety	FSD & ODS
Type of heat	Radiant
Heat Input - HIGH	6.9kW
Heat Input - LOW	4.2kW
Heat Output - HIGH	4.0kW
Heat Output - LOW	1.5kW
Air vent required	Not normally

Options

Fuel



Natural Gas LPG+

Chimney or Flue



Brick Chimney Pre-Fabricated

Control



Manual Slide Fully Remote

Back design



Plain

Oasis Low Lintel model only available in manual control for use on natural gas.
*Only available with Oasis Manual Control.

Dimensions

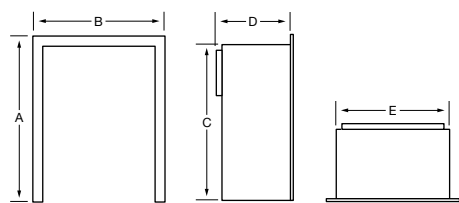

Oasis

- A 594mm
- B 485mm
- C 550mm
- D 250mm
- E 400mm

Oasis Low Lintel

- A 544mm
- B 485mm
- C 500mm
- D 270mm
- E 400mm

Oasis





Caesar

The Caesar is a full depth convector fire featuring a highly realistic coal fuel effect and is available in manual, slide or fully automatic remote control.

It has a heat output of 4.0kW and comes complete with a very luxurious polished silver cast iron trim and fret that makes it equally at home in either a contemporary or more traditional room setting.

Specifications

Safety	FSD & ODS
Type of heat	Radiant & Convected
Heat Input - HIGH	6.9kW
Heat Input - LOW	4.2kW
Heat Output - HIGH	4.0kW
Heat Output - LOW	1.5kW
Air vent required	Not normally

Options

Fuel



Natural Gas LPG

Chimney or Flue



Brick Chimney Pre-Fabricated

Control



Manual Slide Fully Remote

Back design



Plain

Dimensions

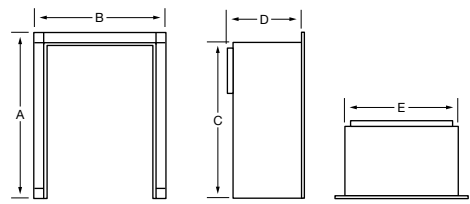

A 505mm
B 590mm
C 550mm
D 250mm
E 400mm





Finishing touches

Complete the look of your chosen gas fire range with our range of fascias, trims & frets

Trims

Designer trim

Made from extruded aluminium, Designer trims create fabulous dual-coloured looks in a choice of six combinations. Suitable for the Nevada Plus, Kalahari Plus, Oasis Plus, Nevada HE, Kalahari HE, Oasis HE, Nevada, Kalahari and Oasis† fires.



Standard trim

Quality steel trims in a choice of four colours.. Suitable for the Nevada Plus, Kalahari Plus, Oasis Plus, Nevada HE, Kalahari HE, Oasis HE, Nevada, Kalahari, Oasis, Oasis LL†† and Revolution fires.



Cast iron and Caesar trims

The Cast and Caesar trims are made from cast iron (black and polished silver) and cast brass. Both designs are suitable for the Nevada Plus*, Kalahari Plus*, Oasis Plus*, Nevada HE*, Kalahari HE*, Oasis HE*, Nevada*, Kalahari* and Oasis* fires.

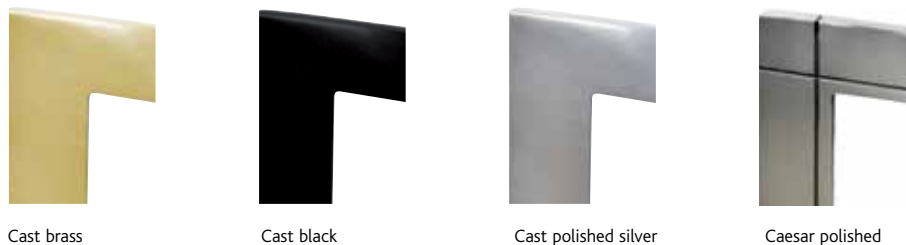

Chamfered trim

Made from steel in a choice of two colours. Suitable for the Nevada Plus*, Kalahari Plus*, Oasis Plus*, Nevada HE*, Kalahari HE*, Oasis HE*, Nevada*, Kalahari*, Oasis*, and Revolution fires.



Wide trim

Made from steel and is only available in a brass colour finish. Suitable for the Nevada Plus*, Kalahari Plus*, Oasis Plus*, Nevada HE*, Kalahari HE*, Oasis HE*, Nevada*, Kalahari*, Oasis*, and Revolution fires.



Fascias



Camber satin silver



Camber champagne



Black Magic

The Camber

The Camber fascia is made from high quality extruded aluminium and is available in silver or champagne finishes. The Camber in silver is suitable for the Nevada Plus*, Kalahari Plus*, Oasis Plus*, Nevada HE*, Kalahari HE*, Oasis HE*, Nevada*, Kalahari*, Oasis*, and Revolution† fires.

†Only available with Camber in silver finish.

The Black Magic

The Black Magic fascia is made from high quality extruded aluminium and comes in beautiful black paint with a fine textured finish. The Black Magic is suitable for the Nevada Plus*, Kalahari Plus*, Oasis Plus*, Nevada HE*, Kalahari HE*, Oasis HE*, Nevada*, Kalahari*, Oasis*, and Revolution fires.

Frets

Each of these frets is suitable for every hearth mounted gas fire in the Kinder range. The black and polished silver frets are made from cast iron, and the brass and antique brass are made from cast brass.

Dallas



Dallas black



Dallas brass



Dallas polished silver



Dallas antique brass

Vegas



Vegas black



Vegas brass



Vegas polished silver



Vegas antique brass

Bauhaus



Bauhaus black



Bauhaus brass



Bauhaus polished silver



Caesar polished silver

Athena



Athena black



Athena brass



Athena polished silver

Aegis



Aegis black



Aegis brass



Aegis polished silver

*Not available for slide control models. † Not available on the low lintel (LL) model †† Only available in brass or black colour options.

Powerflue installation possibilities

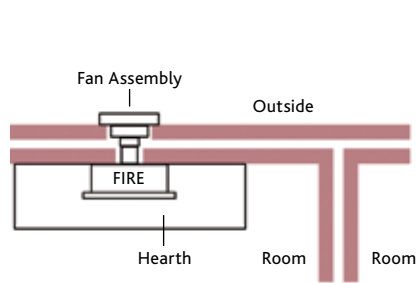

An example of a standard powerflue installation. The gas fire is flued directly through an outside wall via a straight, horizontal length of flue.

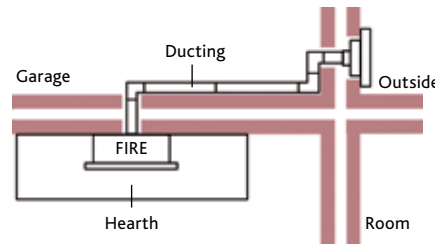

An example of a powerflue installation using three bends.

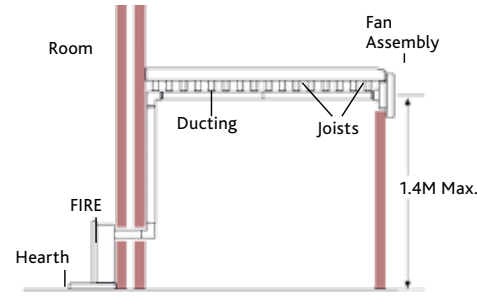

An example of a powerflue installation using a vertical section of flue pipe and two bends.

Kinder powerflue fires



A gas fire creates a welcoming heart to any living room but many newer homes are being built without a chimney or flue so a conventional gas fire is not an option.

However, powerflue (PF) gas fires have been specifically designed for homes without a conventional flue system providing a gas fuelled alternative heat source to an electric fire or radiator.

Several of the models in the Kinder range are available as a powerflue model including the Black Magic, Camber, Kalahari and the Nevada.



The Kinder Slimline Fan System fully recessed into an outside wall leaving only a discreet 3" projection. 96mm and 183mm spacers are available if required.

Example of powerflue installation

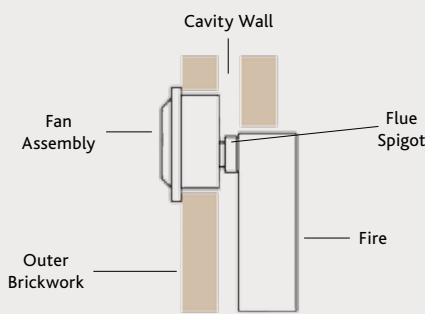

Nevada PF

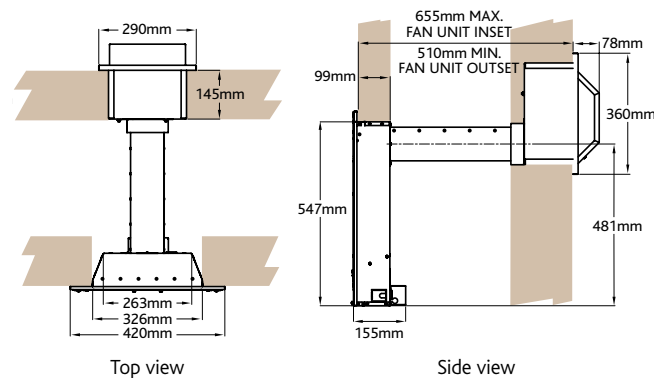

Kalahari MC PF, Camber MC PF and Black Magic MC PF

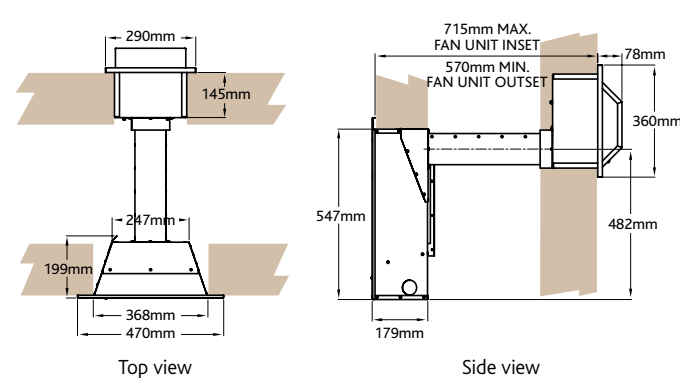

Please note, if required, more detailed information regarding technical specification is available from your Kinder stockist.

Fire Surrounds

Quality & choice as standard

Kinder Fire Surround Suites have been designed to impress, with the emphasis firmly on clean lines. This range of traditional and contemporary designs is manufactured in luxurious Portuguese Limestone.

Portuguese Limestone

Portuguese Limestone is a natural product and as such can be subject to variation in colour and veining. Small fossils and crystal lines may also be apparent in some sections of limestone making it an inherent feature of the product. These are not defects but mean that every suite will be entirely unique.

It is normally a requirement that all Limestone products be cleaned and sealed using Lithofin Power-Clean and Stain-Stop, or equivalent products, after installation. However, all Limestone products supplied by Kinder are pre-sealed to limit any marks which may be left on the product due to installation and further sealing should not be required.

When you receive your new surround there may be some colour variations. This is typical of Portuguese Limestone as the stone is a particularly porous material which absorbs moisture during manufacture and deep sea transport in the container. After 2-3 weeks in a room with an average temperature the surround will dry to a consistent colour.

For more information visit www.bfm-europe.com



Verona - page 23



Genoa - page 51



Venice



Leon - page 59

Surrounds Dimensions

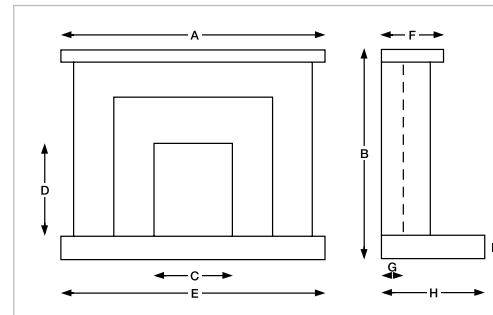

	A	B	C	D	E	F	G	H	I
Genoa	1350mm	1115mm	425mm	565mm	1370mm	200mm	75mm	380mm	55mm
Leon	1370mm	1070mm	425mm	565mm	1370mm	200mm	75mm	400mm	50mm
Venice	1340mm	1075mm	425mm	565mm	1370mm	180mm	75mm	380mm	55mm
Verona	1290mm	1085mm	425mm	565mm	1370mm	185mm	75mm	380mm	55mm

IMPORTANT NOTICE

WARNING BFM Europe Limited is a Gas Safe Register company. We recommend that all of our fires are installed by Gas Safe Register engineers in accordance with our instructions.

DISCLAIMER Our policy is one of constant development and improvement. We therefore reserve the right to revise designs and specifications of our products without formal notice, patents pending. We always recommend our products be viewed in an approved showroom before purchase. Whilst we have taken every care in the preparation of this brochure it is not intended to replace the installation manual which provides more detailed information. Photography is for illustration purposes only and although every effort has been made to ensure accurate reproduction of typical installations and flame pictures they may vary according to fire model and flue types.

We accept no liability for any loss or damage arising directly or indirectly from the use of this brochure.

We recommend that all our fires are used in conjunction with central heating and not as a primary source of heat.

In the interests of personal safety a suitable fireguard is recommended when children, the elderly and the infirm are present. (This brochure is copyright 2012 and must not be reproduced in whole or in any part without prior written permission).